

Darlek

Range of LED light fittings



LMIS2152
Darlek Spiral

LMIS1771
Darlek Smooth

LMID1692
Darlek Fixed

LMID1702
Darlek Adjustable

LMID1711
Darlek Mains

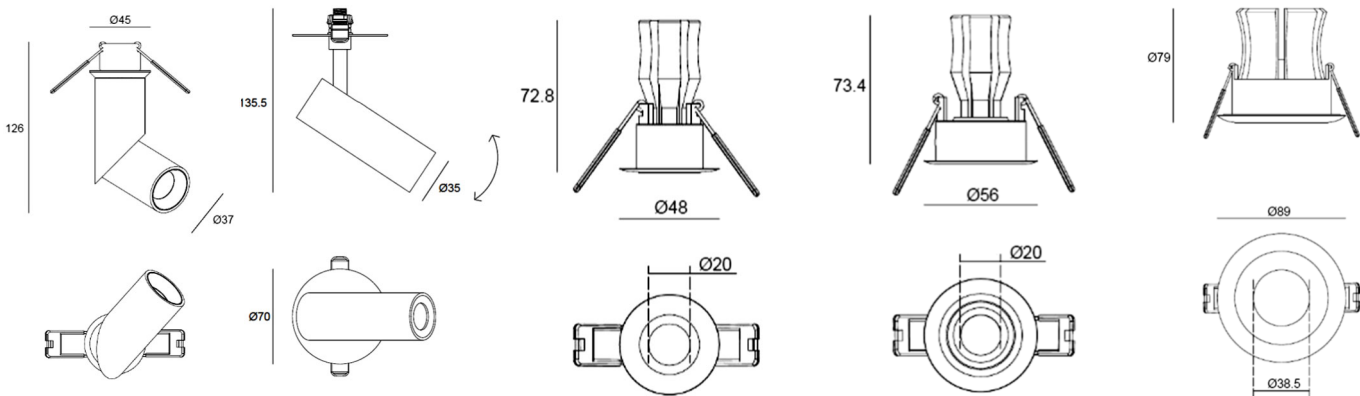

from  **LIGHTMASTER**
PRODUCT

The Darlek range of adjustable and fixed downlights, with complimentary adjustable spotlights is ideal for residential spaces, typically used in any location requiring a discreet but adjustable light source.

The fitting material is mainly aluminium making it suitable for interior use only. Our complete range allows versatility in positioning, which is critical to be able to create the accent, task effect or to boost your general light levels. To keep glare to a minimum, considerate positioning will highlight the subject with its warm light colour, making this a flexible discreet lighting tool.

The white matt sand textured surface finish helps this product to disappear into its surroundings. To ensure you get the best effect our lighting designers are on hand to advise.

Product & Ordering information is overleaf.

Show me more...

Further information, products and our design services can be found on our website at www.lightmaster-product.co.uk

Get in touch with **LIGHTMASTER**:









Lightmaster-Direct Ltd, Unit 17, Blackwell Business Park, Shipston-on-Stour, Warwickshire CV36 4PE
t: 01608 682115 f: 01608 682114 e: sales@lightmaster-direct.co.uk w: www.lightmaster-direct.co.uk



Darlek

Range of LED fittings

Product & Ordering information:

Order as:	Power	Lumens	Beam Angle	C.R.I.	C.C.T.	Driver	Current	I.P. Rating	Mount
LMIS2152-WHM-030-3000-80 Mini adjustable spotlight Darlek Spiral White matt 	6W	486lm	30°	80 Ra	3000°K	Not included	500mA	20 Insulation Class 3	Through hole
LMIS2152-BKM-030-3000-80 Mini adjustable spotlight Darlek Spiral Black matt 									
LMIS2152-NIB-030-3000-80 Mini adjustable spotlight Darlek Spiral Satin nickel 									
LMIS2152-CSA-030-3000-80 Mini adjustable spotlight Darlek Spiral Brushed bronze 									
LMIS1771-WHM-030-3000-80 Mini adjustable spotlight Darlek Smooth White matt 	6W	486lm	30°	80 Ra	3000°K	Not included	500mA	20 Insulation Class 3	Through hole
LMIS1692-WHM-030-3000-80 Mini fixed downlight Darlek Fixed White matt 	6W	486lm	30°	80 Ra	3000°K	Not included	500mA	20 Insulation Class 3	Recessed
LMIS1702-WHM-030-3000-80 Mini adjustable downlight Darlek Adjustable White matt 	6W	486lm	30°	80 Ra	3000°K	Not included	500mA	20 Insulation Class 3	Recessed
LMIS1711-WHM-040-3000-80 Mains fixed downlight Darlek Mains White matt 	5W	450lm	40°	80 Ra	3000°K	220-240V AC Integral, Mains Not dimmable.		20 Insulation Class 1	Recessed



Show me more...

Further information, products and our design services can be found on our website at www.lightmaster-product.co.uk

Get in touch with LIGHTMASTER:

Lightmaster-Direct Ltd, Unit 17, Blackwell Business Park, Shipston-on-Stour, Warwickshire CV36 4PE
t: 01608 682115 f: 01608 682114 e: sales@lightmaster-direct.co.uk w: www.lightmaster-direct.co.uk

